

Blast Chiller Freezers Crosswise Blast Chiller-Freezer Crosswise - 15 kg 5GN 1/1 (R452A) 60Hz

ITEM # _____

MODEL # _____

NAME # _____

SIS # _____

AIA # _____

725209 (ECBCFA015SB)

 Blast Chiller & Freezer
 Crosswise 15kg, compatible
 with 6x1/1GN Convection
 Oven Crosswise - R452A -
 60Hz

Short Form Specification

Item No.

Blast chiller/freezer with digital temperature and time display. For 5 GN 1/1 or 600x400 mm trays (h = 65 mm). Load capacity: chilling 15 kg; freezing 5 kg. Automatic detection of food probe insertion. Automatic and Manual defrost. Blast chilling real remaining time estimation (A.R.T.E.). Turbo cooling function. Thawing function. HACCP and Service alarms with data logging. Connectivity ready. Operating air temperature: +10/-34°C. Single sensor food probe. Main components in 304 AISI stainless steel. Internal rounded corners and drain. Evaporator with antirust protection. Performances guaranteed at ambient temperature of +40°C. Cyclopentane insulation (HCFC, CFC and HFC free). R452a refrigerant gas (HCFC and CFC free). Built-in refrigeration unit.

Main Features

- Blast Chilling cycle: 15 kg from 90°C up to 3°C in less than 90 minutes.
- Chilling cycle with automatic preset cycles:
 - Soft Chilling (air temperature 0°C), ideal for delicate food and small portions.
 - Hard Chilling (air temperature -12°C), ideal for solid food and whole pieces.
- Freezing cycle with automatic preset cycles (air temperature -34°C), ideal for all kind of food (raw, half or fully cooked).
- Turbo cooling: chiller works continuously at the desired temperature; ideal for continuous production.
- Thawing cycle (air temperature 7°C), ideal for defrosting food in a controlled and safe environment.
- Possibility to modify the cavity temperature in turbo cooling and thawing cycles.
- Remaining time estimation for probe-driven cycles based on artificial intelligence techniques (ARTE) for an easier planning of the activities.
- Single sensor core probe as standard.
- Control unit provides two large displays to read out: time, core temperature, cycle countdown, alarms, service information.
- On-board HACCP monitoring capable.
- Connectivity ready for real time access to connected appliances from remote and HACCP monitoring (requires optional accessory).
- Performance guaranteed at ambient temperatures of +40°C (Climatic class 5).
- Automatic and manual defrosting.
- Working temperature from +90°C to +3°C in chilling mode or to -34°C in freezing mode.

Construction

- No water connections required.
- Ventilator swinging hinged panel for access to the evaporator for cleaning.
- Waste water can be plumbed into drain, but can also be collected in an optional waste container.
- Environmentally friendly: R452a as refrigerant gas.
- Built-in refrigeration unit.
- Removable magnetic door gasket with hygienic design.
- 5 levels available. Usable with 5 GN 1/1 or 600x400 mm trays (h = 65 mm).
- Main components in 304 AISI stainless steel.
- Evaporator with antirust protection.
- Hygienic shape with rounded corners (and drain for easy cleaning).
- Automatic heated door frame.
- Door reversible on site.
- Door stopper to keep the door open in order to avoid the formation of bad smells (kit available to be mounted on site, depending on preferred door hinge).
- IP21 protection index.

APPROVAL: _____



Sustainability

- Holding at +3 °C for chilling or -20 °C for freezing, automatically activated at the end of each cycle, to save energy and maintain the target temperature (manual activation is also possible).
- High density polyurethane insulation, 60 mm thickness, HCFC free.

Included Accessories

- 1 of 1 single-sensor probe for blast chiller/freezers PNC 880213

Optional Accessories

- 1 single-sensor probe for blast chiller/freezers PNC 880213
- Kit 4 feet for blast chiller/freezers crosswise 15-25 kg - h100mm PNC 881295
- Kit 4 wheels for blast chiller/freezers crosswise 15-25 kg - h100mm PNC 881296
- Pair of AISI 304 stainless steel grids, GN 1/1 PNC 921101
- Pair of AISI 304 stainless steel grids, GN 1/1 PNC 922017
- AISI 304 stainless steel grid, GN 1/1 PNC 922062
- AISI 304 stainless steel bakery/pastry grid 400x600mm PNC 922264
- IoT module for blast chiller/freezers crosswise PNC 922419
- POE switch PNC 922432

Front

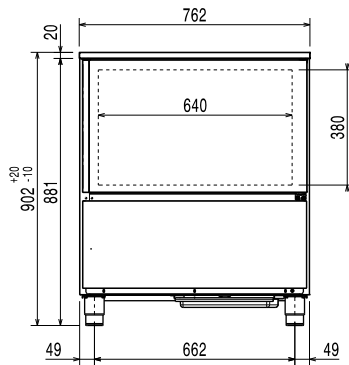

Side

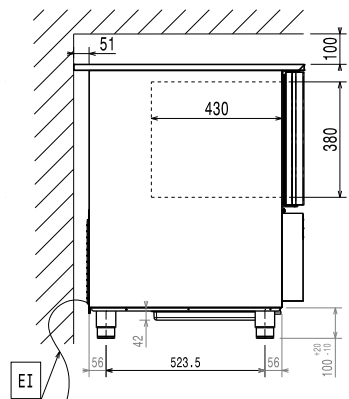

EI = Electrical inlet (power)

Top

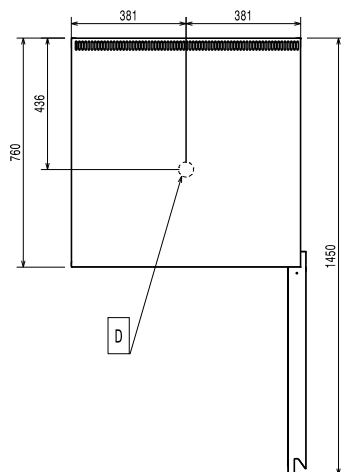

Electric

Supply voltage:

725209 (ECBCFA015SB) 220-230 V/1 ph/60 Hz

Electrical power max.:

0.83 kW

Circuit breaker required

Installation:

Clearance:

5 cm on sides and back.

Please see and follow detailed installation instructions provided with the unit

Capacity:

Trays type:

GN 1/1;600x400

Key Information:

External dimensions, Width: 762 mm

External dimensions, Depth: 760 mm

External dimensions, Height: 902 mm

Net weight: 85 kg

Shipping weight: 97 kg

Shipping volume: 0.72 m³

Refrigeration Data

Refrigeration power at

evaporation temperature: -20 °C

Condenser cooling type: AIR

Test performed in a test room at 30°C to chill/ freeze (+10° C/-18° C) a full load of 40mm deep trays filled with mashed potatoes evenly distributed up to a height of 35 mm at starting temperature between 65° and 80°C within 120/270min.

ISO Certificates

ISO Standards:

ISO 9001; ISO 14001; ISO 45001; ISO 50001

Sustainability

Refrigerant type:

R452A

GWP Index:

2141

Refrigeration power:

777 W

Refrigerant weight:

380 g